

Step INTO THE Trades

Colouring and
Activity Book

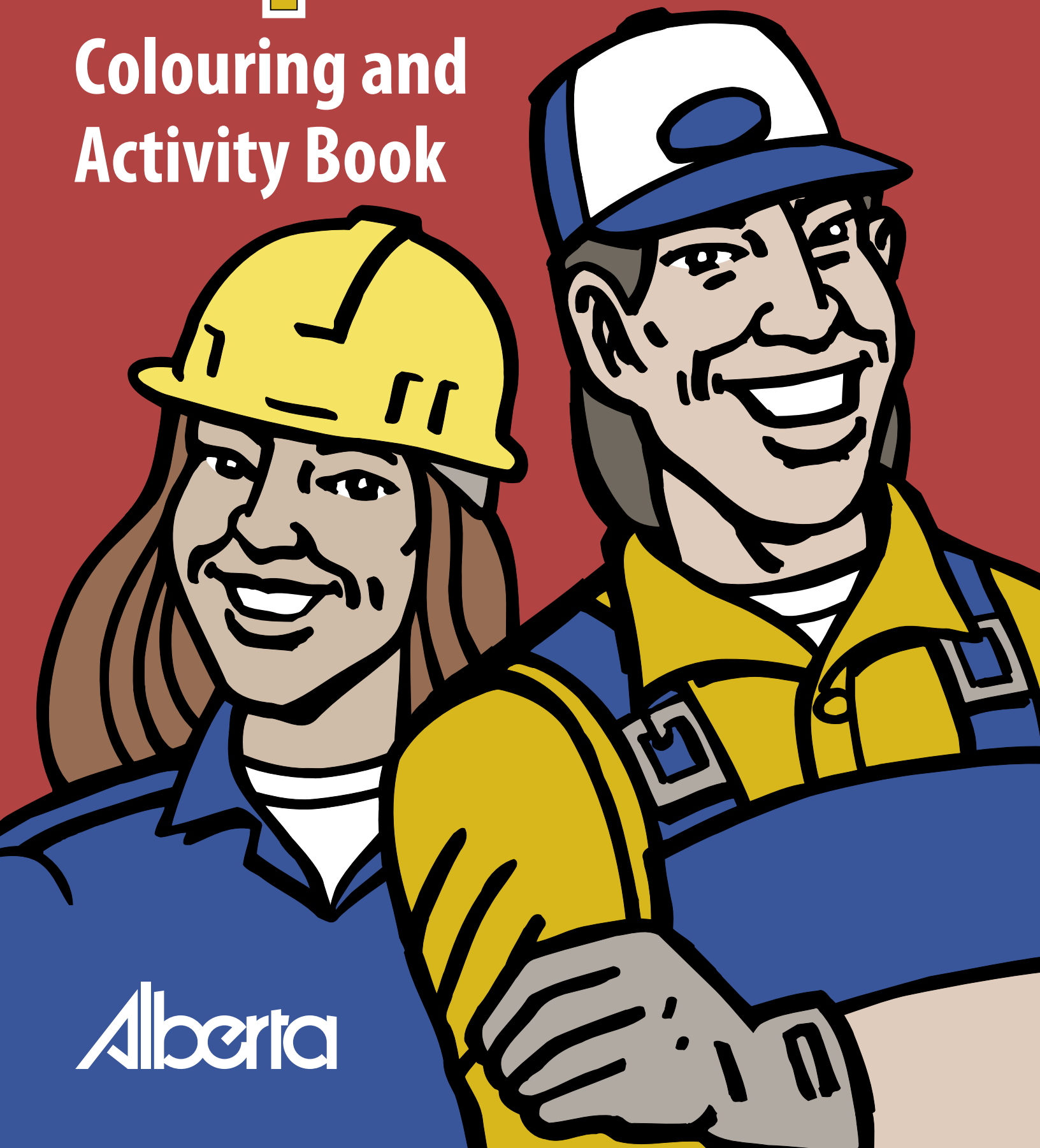

Alberta



Note to parents and educators

This colouring book is for students K - Grade 4 as a companion piece to the *Step into the Trades* playing cards. It is meant to expose young students to the trades as a viable career option. For more information on apprenticeship or for more copies of this colouring book, visit **www.tradesecrets.org**

© 2005 The Crown in Right of the Province of Alberta,
as represented by the Minister of Advanced Education.

ISBN 0-7785-3800-1

Building Trades



Building Word Search

Find the six hidden words shown below
beside the pictures.

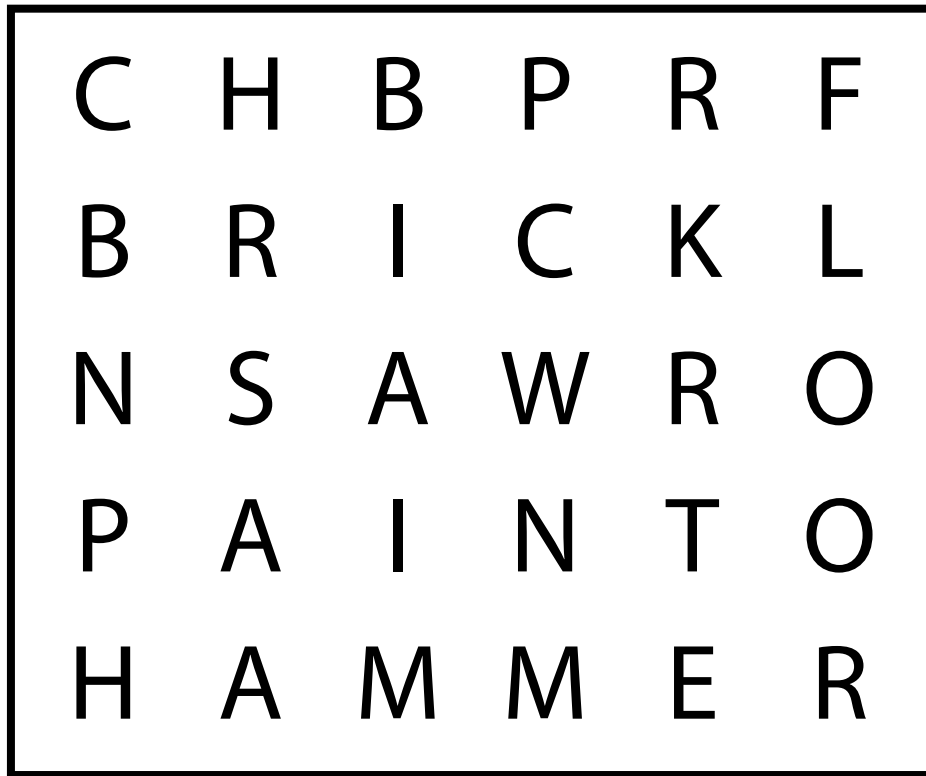

SAW



PAINT

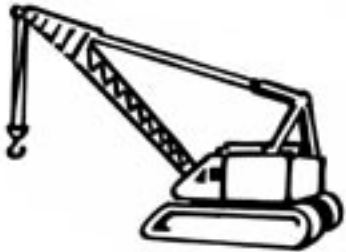

CRANE



HAMMER

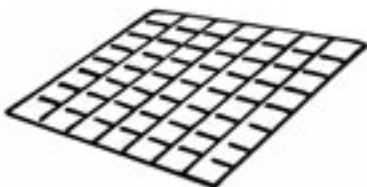

FLOOR

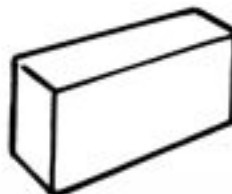

BRICK

Electrical Trades

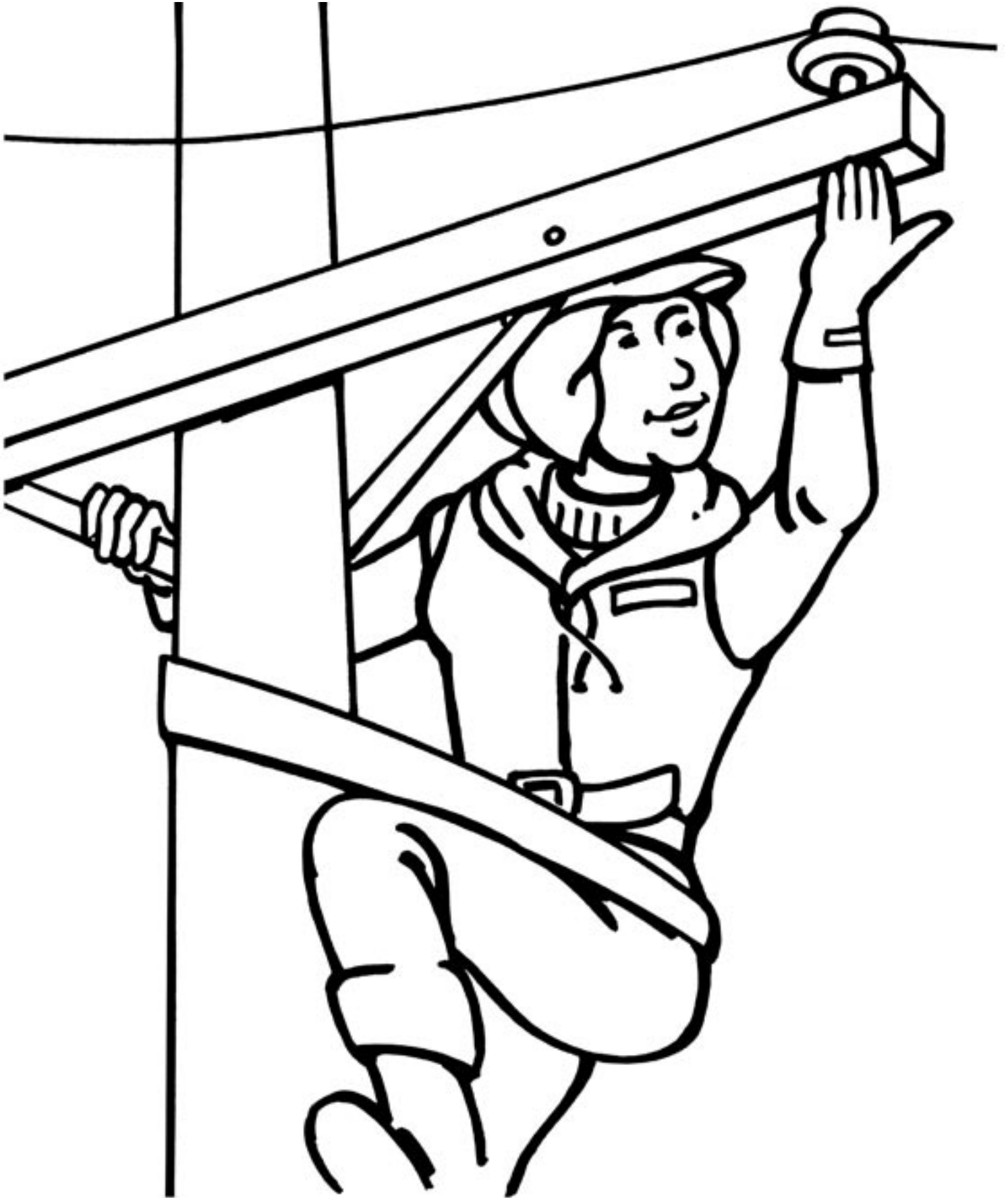

Electrical Match

Electricity is needed for many things we use every day.

Draw a line from each one of the electrical objects showing which daily activity it helps.

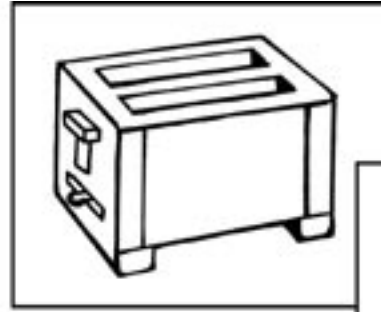
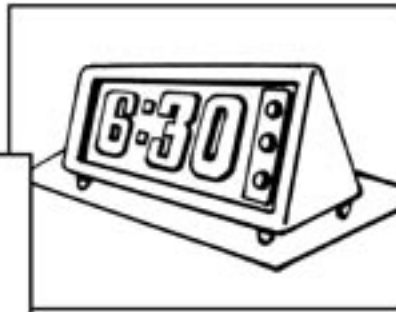

Industrial Trades



Water Well Driller

Start at the truck and find the path to the water.

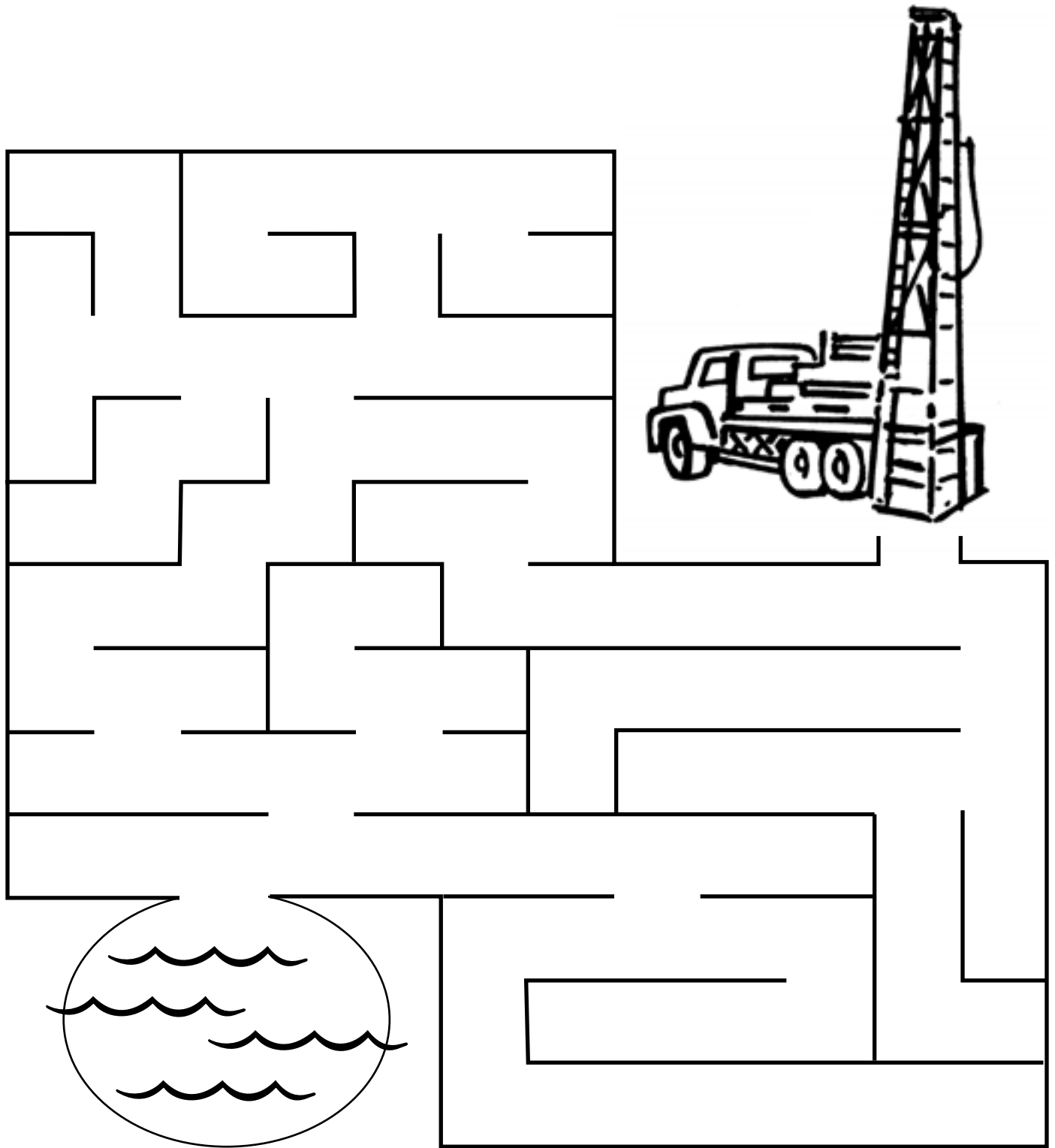

Metal Trades



Metal Dot to Dot

Workers make many things with metal.

Follow the numbers dot to dot to help this car cross the river.

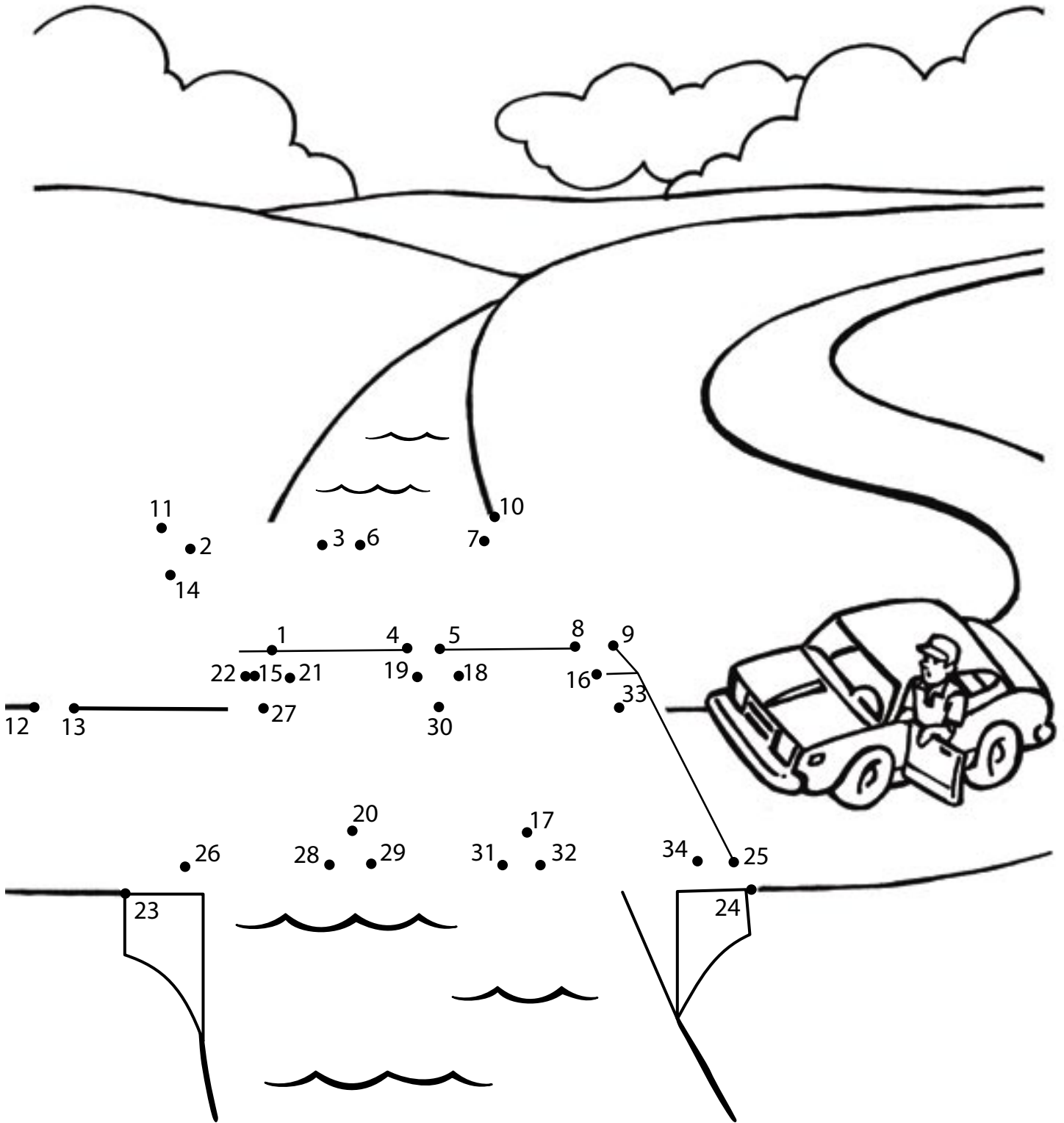

Piping Trades

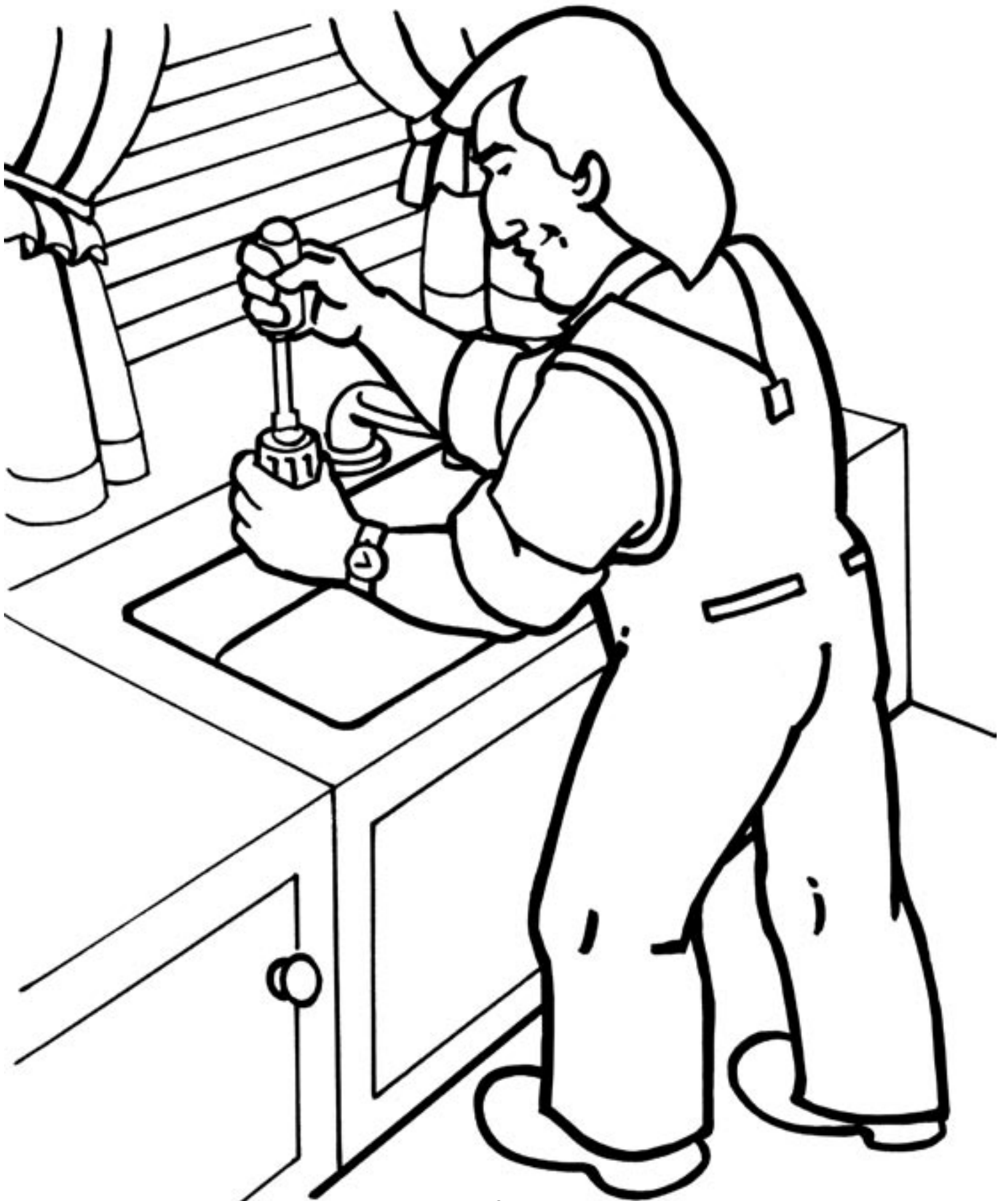

Piping Mystery Tool

Help the plumber find the tool she needs to fix the leaking pipe.

Colour the areas marked with a "B" blue, and colour the areas marked with a "Y" yellow.

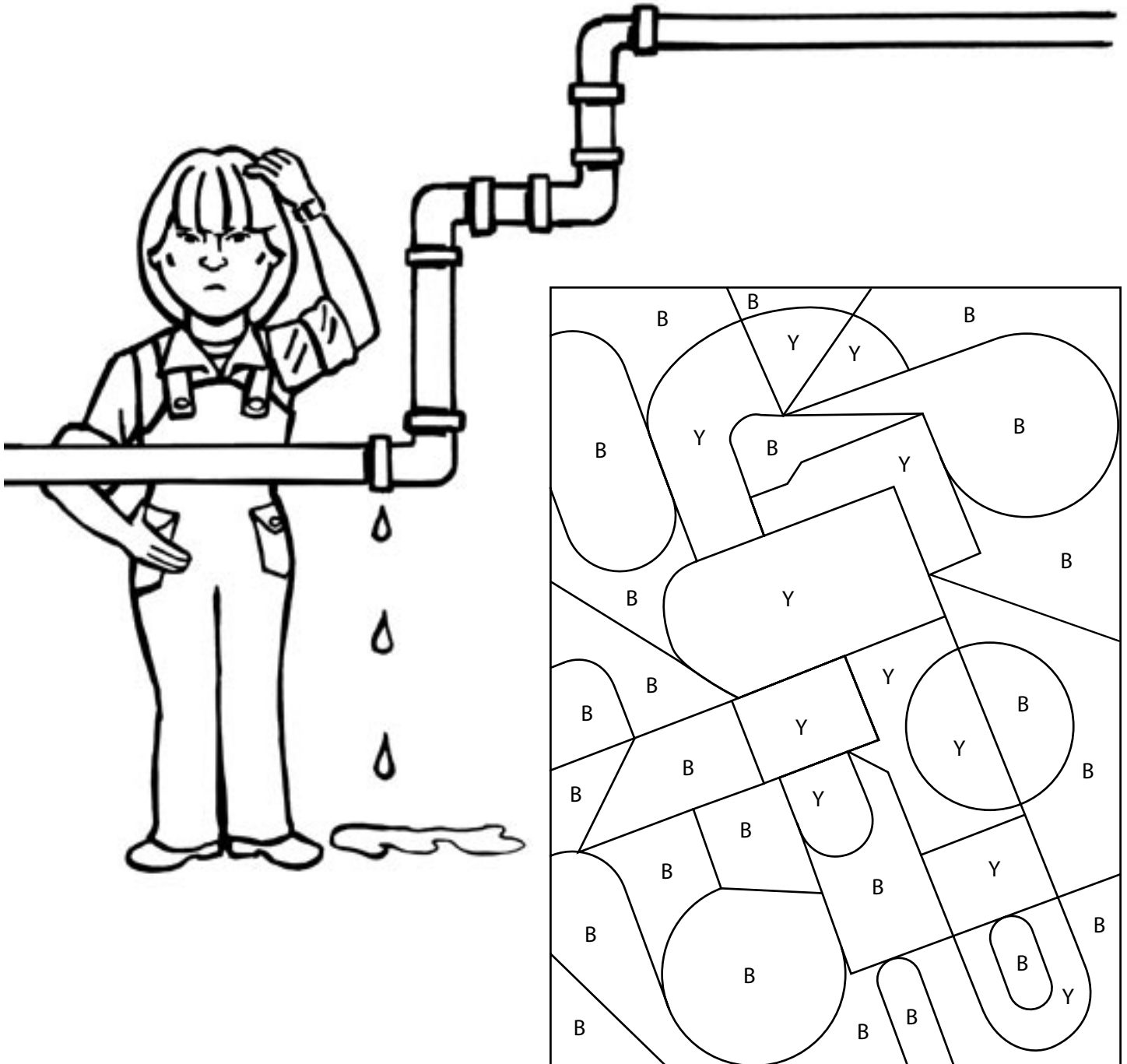

Service Trades



Service Circle Maze

Use a different colour line to connect each worker with the missing tool.

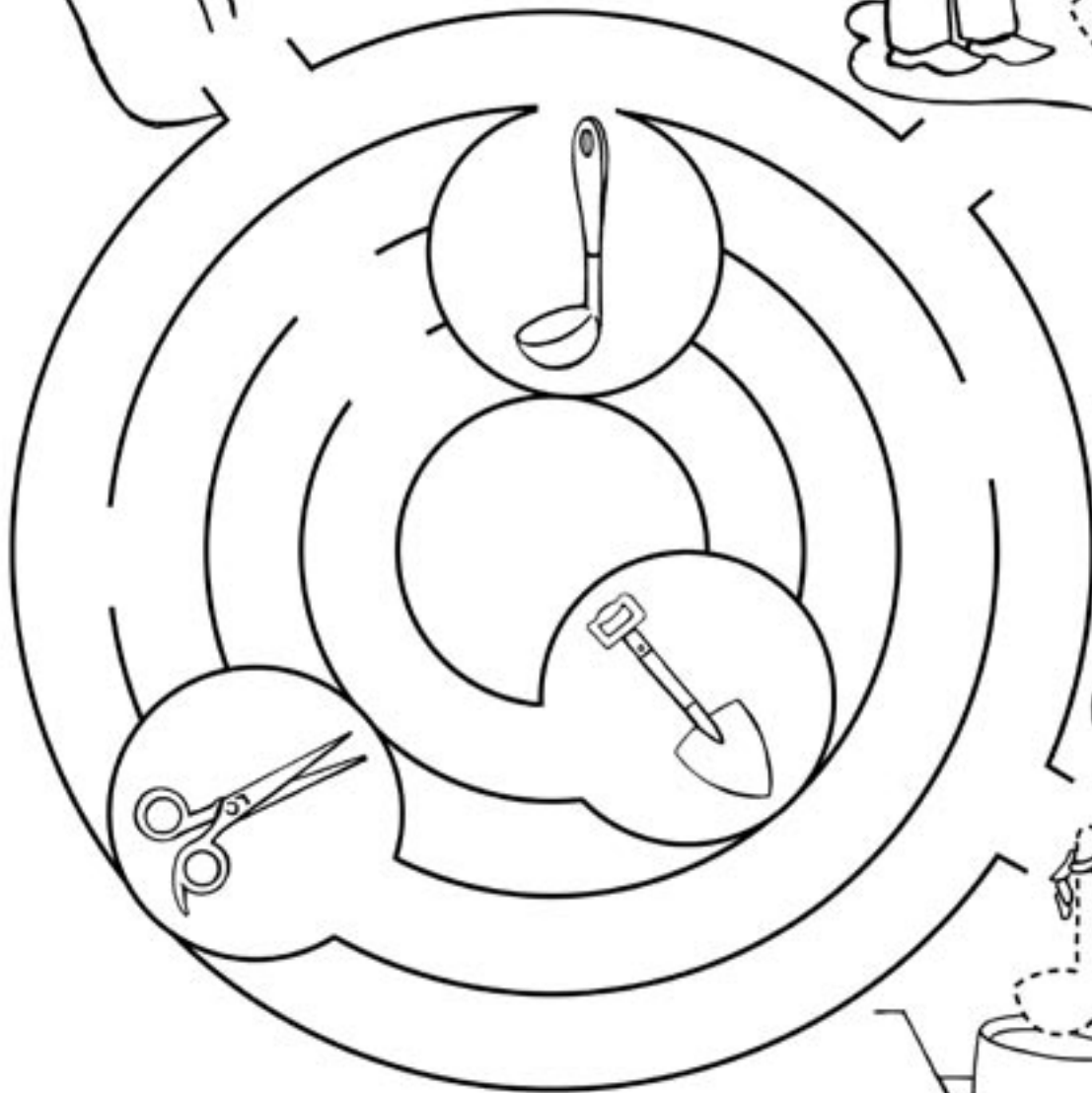

Vehicle/Motor Trades



Vehicle/Motor Crossword

Use the picture clues to fill in the crossword puzzle.



1 across

4 across

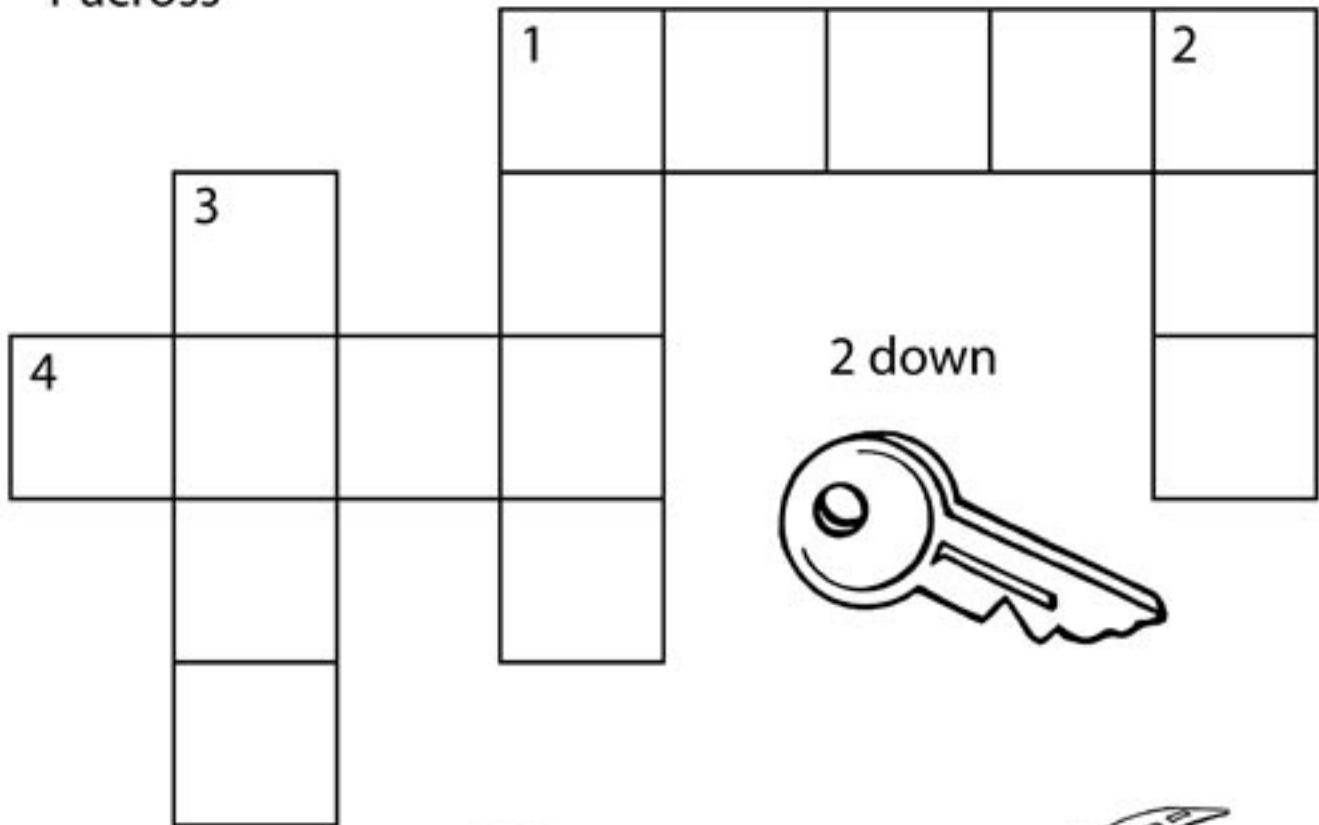

2 down



1 down

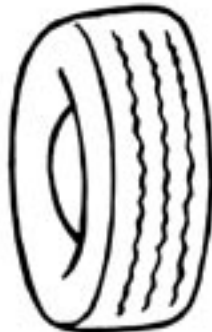

3 down

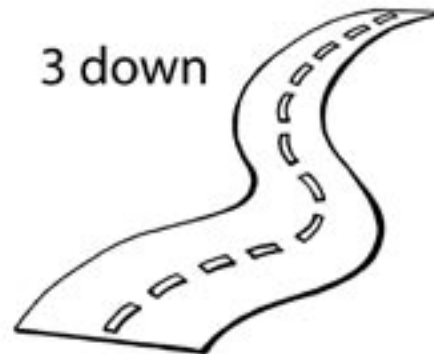

Designated Occupations



Designated Occupations

Dot to Dot

Connect the dots to see how you can move heavy boxes in the warehouse.

WAREHOUSE

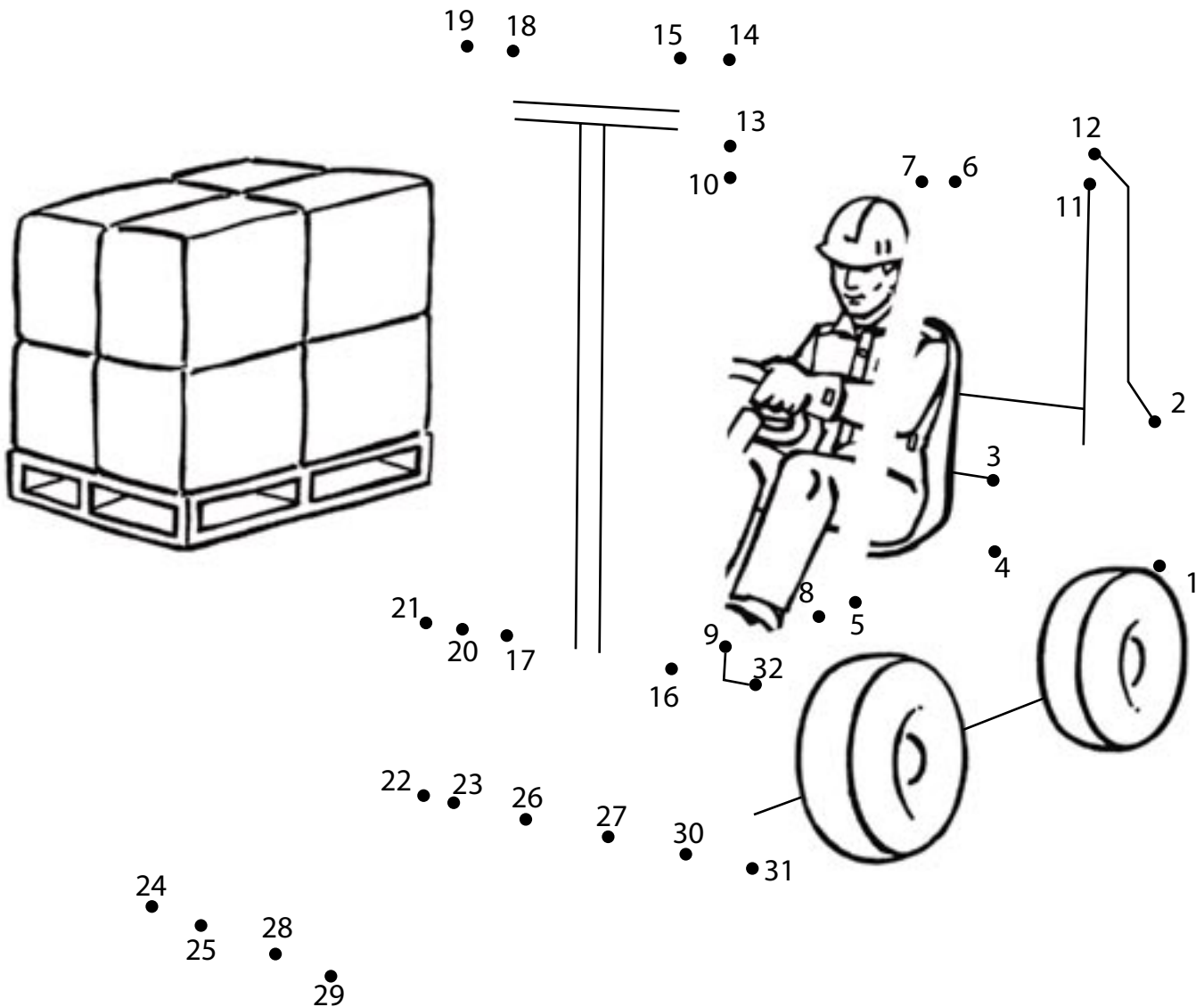



BUILDING TRADES

Bricklayer
Cabinetmaker
Carpenter
Concrete Finisher
Crane and Hoisting
Equipment Operator
Elevator Constructor
Floorcovering Installer
Glazier/Glazier – Auto
Glass Technician
Lather – Interior Systems
Mechanic
Painter and Decorator
Roofer
Tiler

ELECTRICAL TRADES

Communication Technician
Electrical Motor Systems
Technician
Electrician
Electronic Technician
Power Lineman
Power System Electrician

INDUSTRIAL TRADES

Instrument Technician
Insulator
Millwright
Rig Technician
Sawfiler
Water Well Driller

METAL TRADES

Ironworker/
Ironworker – Metal
Building Systems Erector
Machinist
Sheet Metal Worker
Structural Steel and Plate
Fitter
Tool and Die Maker
Welder

PIPING TRADES

Boilermaker
Gasfitter – First Class
Plumber
Steamfitter-Pipefitter
Sprinkler Systems Installer

SERVICE TRADES

Appliance Service
Technician
Baker
Cook
Hairstylist
Landscape Gardener
Locksmith
Outdoor Power Equipment
Technician
Refrigeration and Air
Conditioning Mechanic

VEHICLE/MOTOR RELATED

Agricultural Equipment
Technician
Auto Body Technician
Automotive Service
Technician
Heavy Equipment
Technician
Motorcycle Mechanic
Parts Technician
Recreation Vehicle Service
Technician
Transport Refrigeration
Technician

DESIGNATED OCCUPATIONS

Construction Craft
Labourer
Gas Utility Operator
Oil and Gas Transportation
Services
Steel Detailer
Warehousing
Well Testing Services
Supervisor

